

Produktmerkmal für Panel:

Weißer Rahmen ohne Lücke zwischen den vier Ecken.

1. Hohe Lumen Effizienz bis zu 120lm / w, hohe CRI bis zu 80.
2. Hochleistungsfaktor bis zu 0,9; Niedrige THD, die unter 15% liegt
3. 5 Jahre Garantie
4. Das Panel ist Dimmbar und sowohl die Lichtfarbe wie auch die Dimmung per Fernbedienung zu bedienen!.
5. Eine Fernbedienung kann bis zu 15 Panels gleichzeitig steuern.



Parameter für Panel:

Model	Größe	Volt	Watt	PF	CCT	CRI	Lm/w
BDL-PA6262-40W	620x620*9mm Flicker-free driver 5years warranty	100-240V 50/60Hz	40W	0.9	3000K 4000K 5000k 6000K	80	120

Lichtstärkeverteilung: 120 °

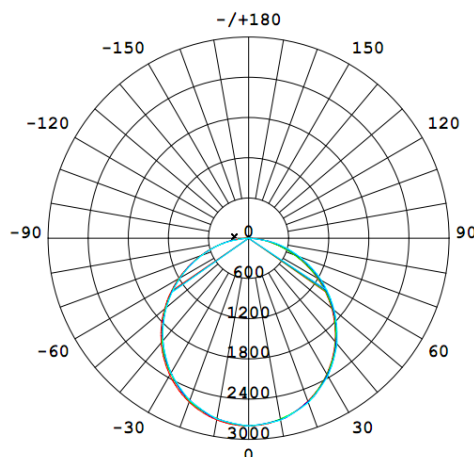

Spektrale Verteilung: 6000K

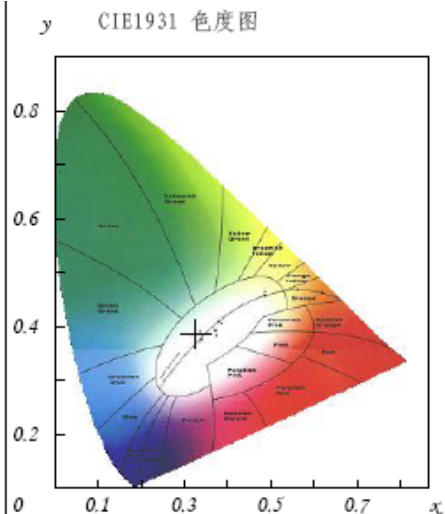
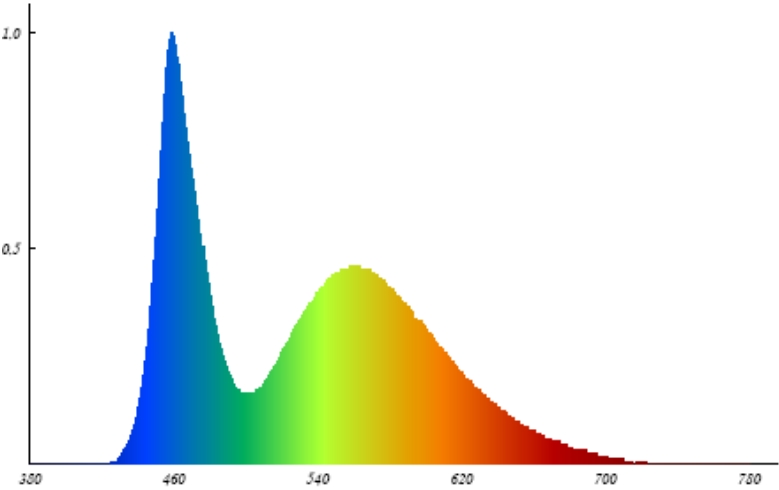

Anschlusschema:

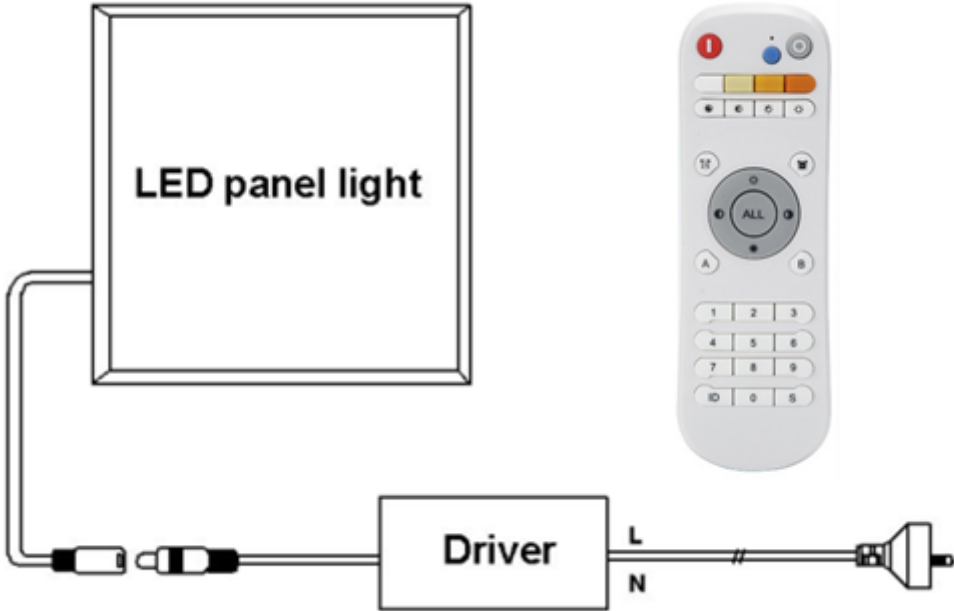

Die Explosions-Grafik:

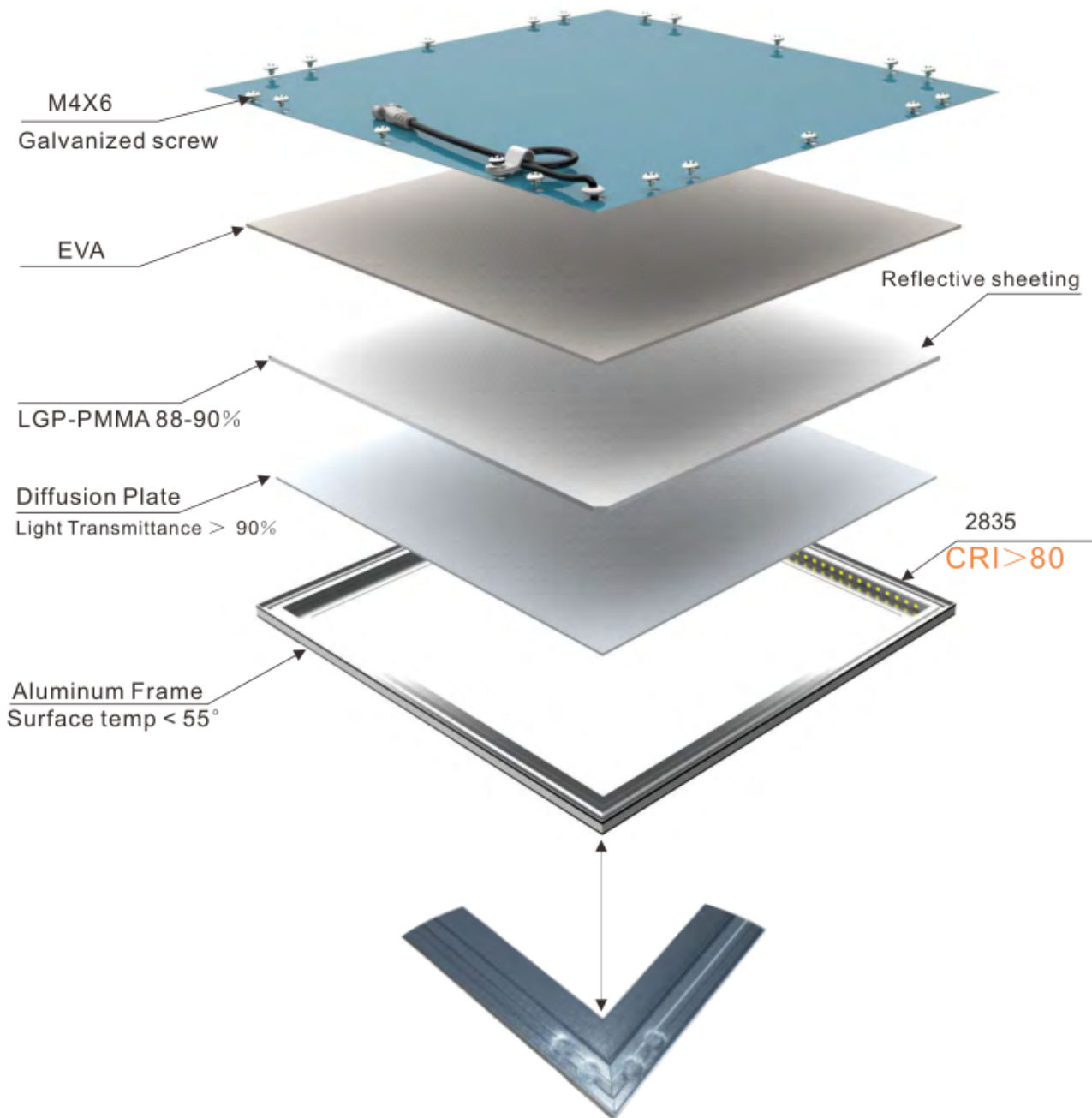

The frame adopts pneumatic splicing
More robust and reliable than the screw joint structure

Installation

Built-in:

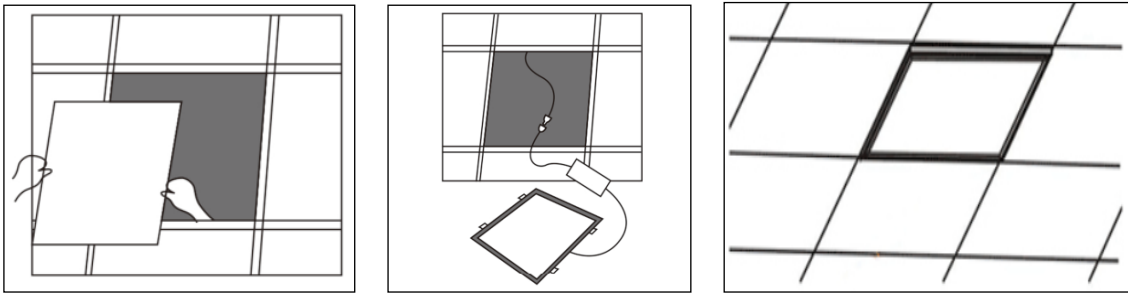

- Take off the ceiling.
- Connect to the wire.
- Place the panel lights steadily, the installation is complete.

Surface mounted:

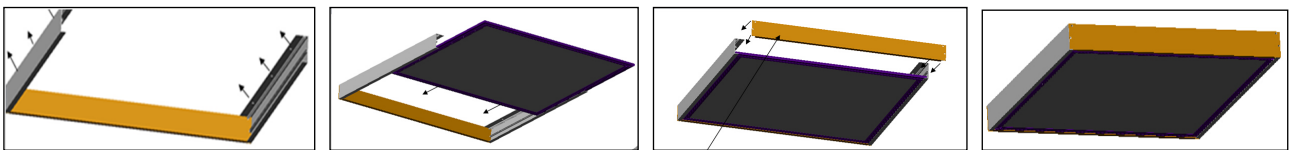

- To make the screws onto the ceiling.
- To put the panel into the frame by the arrow direction.
- Then screw the fourth part frame.
- Installation completed.

Hanging:

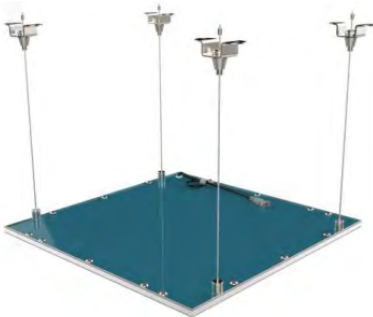

- Take off the cassette, put steel wire rope into cassette.
- Fixed cassette on the ceiling.
- Lock the line devices into the panel.
- Adjust the length of wire cable, and connect power supply, and then switch on.

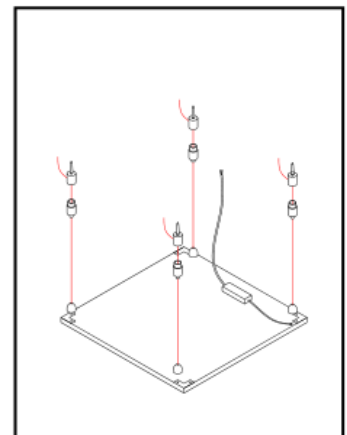
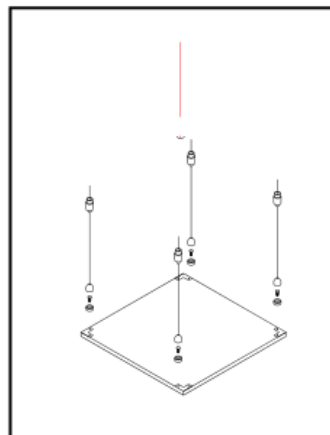
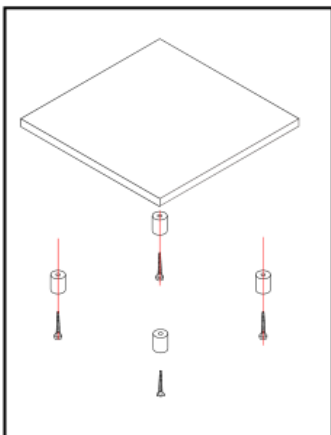

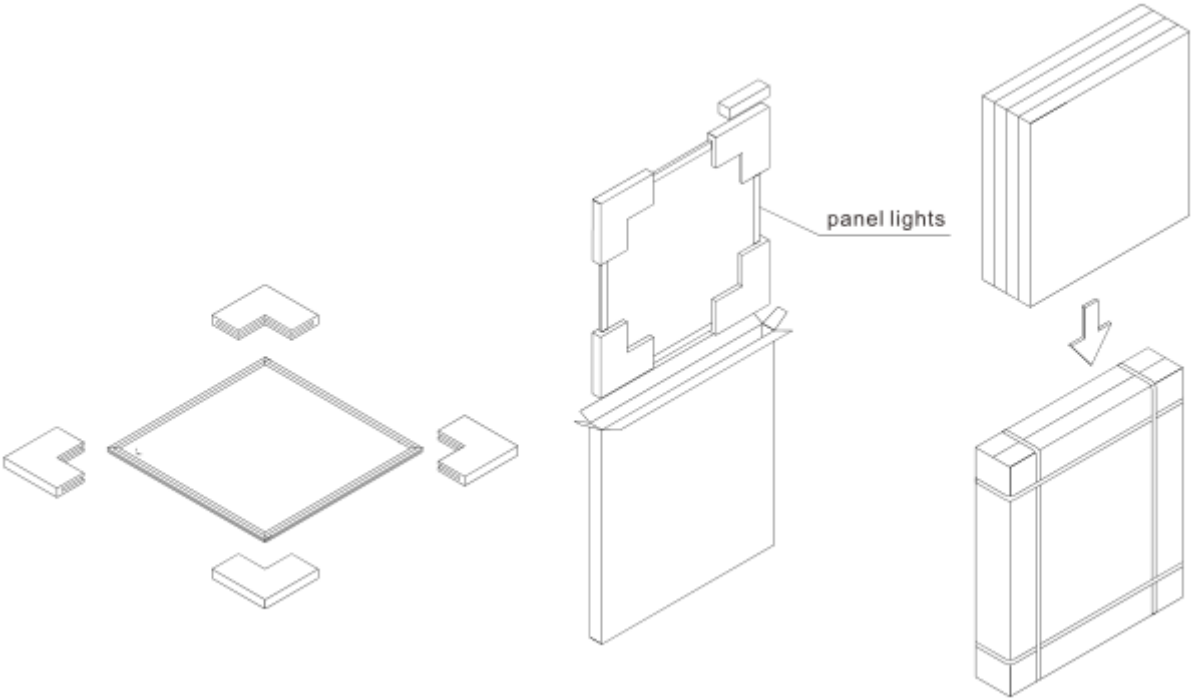

Länge	Karton	W.G/Box	Menge	W.G/ Ctn
620x620mm	720x720x550mm	4kg	5Stk/ Ctn	22Kg